

HORLITE[®]
... Lighting

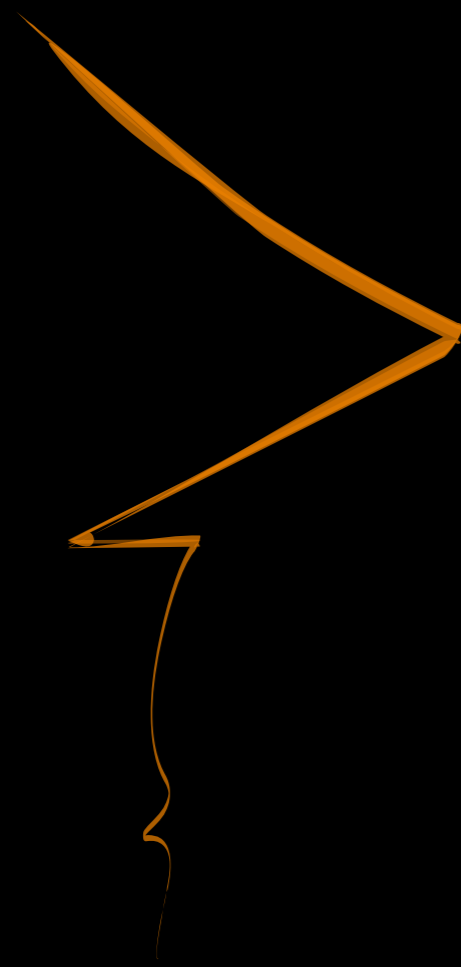

宁波鸿睿照明科技有限公司

NINGBO HONGRUI LIGHTING TECHNOLOGY CO., LTD.

Add: No. 328 Changyuan Road, Yuyao City, Ningbo, Zhejiang, China

Mr. He (G.M) 0086-15924368758

E-mail: austinhe@horlite.com | sales@horlite.com

Website: www.horlite.com

HORLITE[®]
... Lighting



2023
Table Lamp



Ningbo Hongrui Lighting Technology Co., Ltd., founded in 2014, located in Yuyao, Ningbo, is professional engaged in outdoor lights, LED indoor & outdoor lamps, LED garden lights & lawn lights, LED wall lamps, lamp connectors, lamp holders, etc ...

which are widely used in commercial lighting at home & abroad. Also our company system & our products have already passed UL, CE, RoHS, 7P certification, (as well as ETL, cUL now on process by the year 2017~2018) due to we have perfect software and hardware supports below:

1. Our hardware support: advanced precision mold processing capacity, production equipments, testing equipments etc.

2. Our software support: our high quality innovative professional technical team & sales management team.

We have already adopted advanced ERP data control system for all our production process, forming the core competitiveness of "Quality first, attention to talent & efficient service".



ABOUT US



Compliant the latest standards



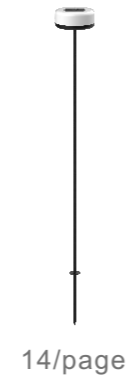
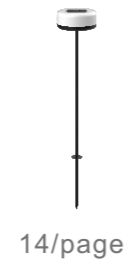
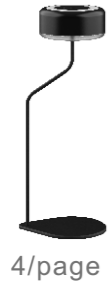

FINISHES
29-46page

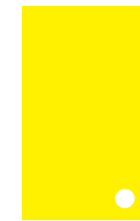
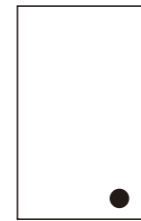

Order your accessories
29-46page

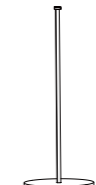
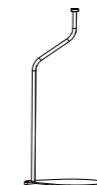
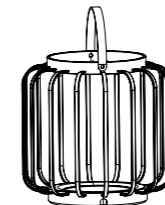
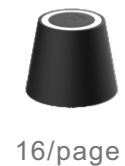



HR95001

Orders your style

Table Lamp

Table Lamp

DIY01-Table Lamp
Art Nr.HR95006

Technical data

- ⊗ 5V,1A input voltage
- ⊗ 2.0W 200lm, led chips
- ⊗ 2x2200mAh Li-ion battery
- ⊗ Plastic material.
- ⊗ Charging time: 7-8h | Working time: >8h

 The battery capacity can be increased

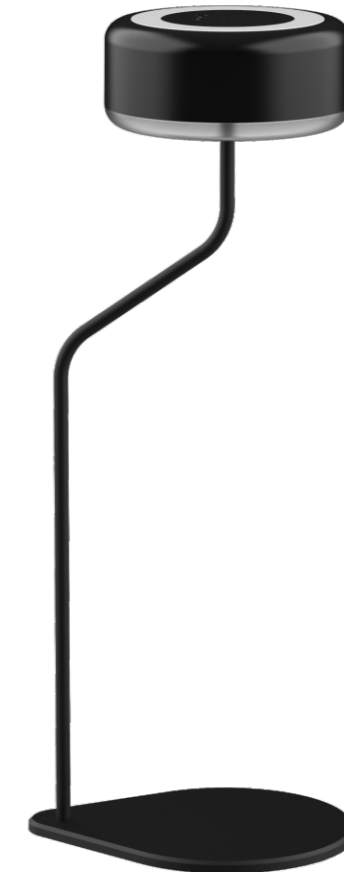

Magnetic Charging | USB1.5M 5V 1A

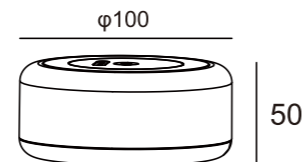

[How to DIY CCT?]

- ⊗ 1.Touch switch to turn on the lamp with 3000K RA>80 color.
- ⊗ 2.Touch switch with the 4000K RA>95 of full spectrum color temperature
- ⊗ 3.Touch switch to turn off the lamp

[How to DIM?]



The table lamp accessories of Water drop shaped

You can grow plants as you like. Meanwhile, RA>95 4000K for full spectrum color temperature that will provide help to the plant growth.

You can place it in as you like.

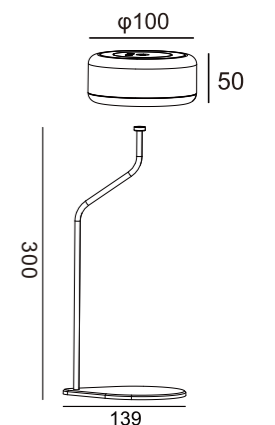
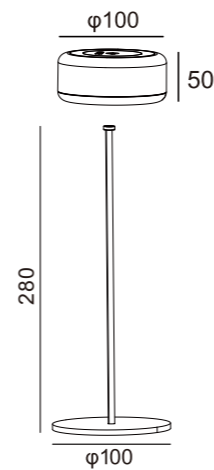

Table Lamp

DIY02-Table Lamp
Art Nr.HR95002-330



It is a multifunctional and portable LED magnetic charging table lamp that can be used as outdoors and indoors. Designed with DIY accessories to suitable for a variety of applications: tables, floors etc.... open Spaces.

Floor Lamp

DIY03-Floor Lamp
Art Nr.HR95003-1100

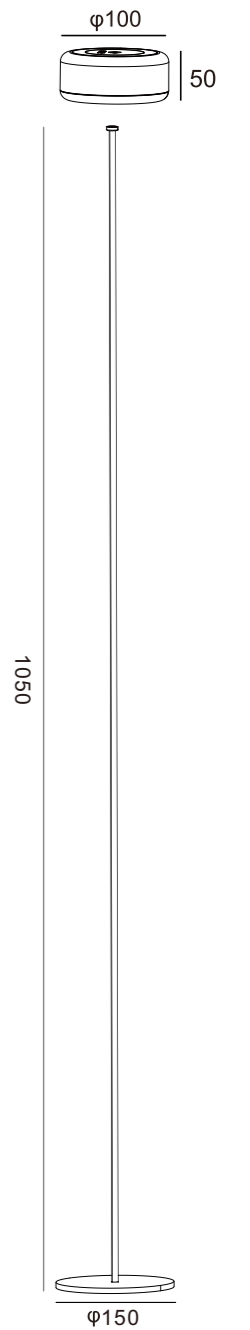

1050mm floor lamp accessories can let you use in the study, office area, leisure area ,cafes, bars, and other areas.

Bottles Lamp

DIY04-Bottles Lamp
Art Nr.HR95005



When you have a collection of beautiful empty bottles
You can choose this accessory. It's alum. material with a
>4 kg of magnetic.

You can use it for indoor desks, office areas, cafes, bars, etc.

outdoor camping during the festival party, dining tables and other areas

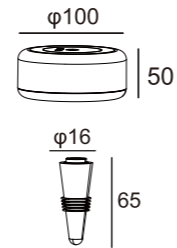

Plug Lamp

DIY05-Plug Lamp
Art Nr.HR95004-400 | HR95004-750



You can use the plug-in accessory when you are
camping or partying outdoors.

The product can be plug into the lawn, next to trees, soft
ground, or next to steps.

We offer two heights of 850mm and 500mm accessories for
you to choose

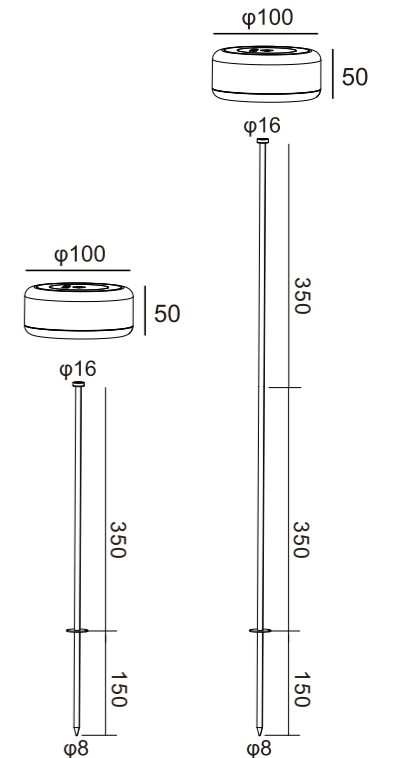



HR95011

Orders your style

Technical data

- ⊗ 5V, 1A input voltage
- ⊗ 2.0W 200lm, led chips
- ⊗ 1x4000mAh Li-ion battery
- ⊗ Plastic material.
- ⊗ Charging time: 6-7h | Working time: >7h

 The battery capacity can be increased

Table Lamp



Magnetic Charging | USB1.5M 5V 1A

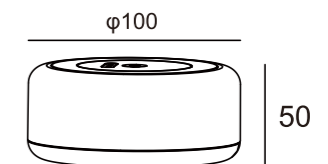

[How to DIY CCT?]

- ⊗ 1: Touch switch to turn on the light with 3000K RA>80 color.
- ⊗ 2: Touch switch with the 4000K RA>80
- ⊗ 3: Touch switch to turn off the lamp

[How to DIM?]



Portable Lamp

DIY01-Portable Lamp
Art Nr.HR95016

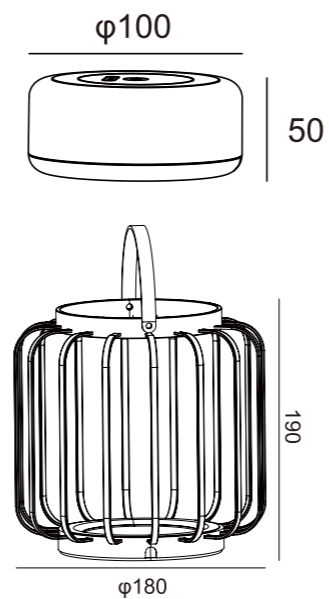

You can put the lamp into this portable lantern frame.

It can be easily hung on the iron hook, rope, branches and so on.

When you need to use it in your daily activities outdoors or indoors.

You can also place it on the floor or on a table.

Hook Lamp

DIY02-Hook Lamp
Art Nr.HR95017

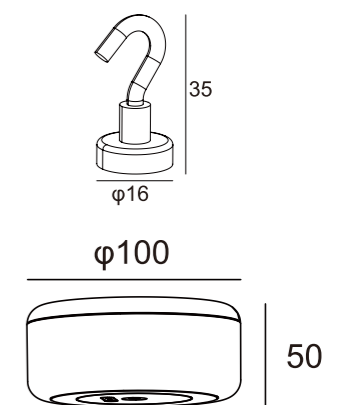

You have a choice for the magnet hook with >4KG magnetic force

This design is mainly used when you are in outdoor or indoor places and need to hang it from hooks, ropes, pipes, or inside camping tents.

Magnetic Lamp

DIY03-Magnetic Lamp
Art Nr. **HR95018**

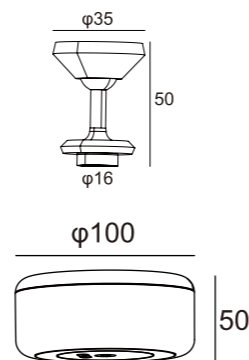
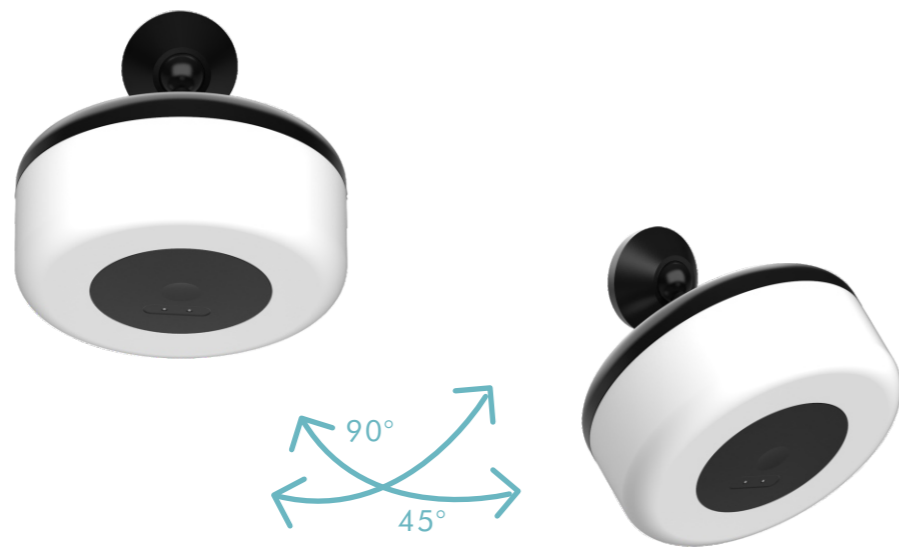

When you're on a trip with your family and friends.

This 45-90° magnetic swivel accessory can add a bit of fun to your trip.

It can be attached to any iron door (e.g. iron frame, car body, iron pipe etc.)

Plug Lamp

DIY04-Plug Lamp
Art Nr. **HR95014-400 | HR95014-750**

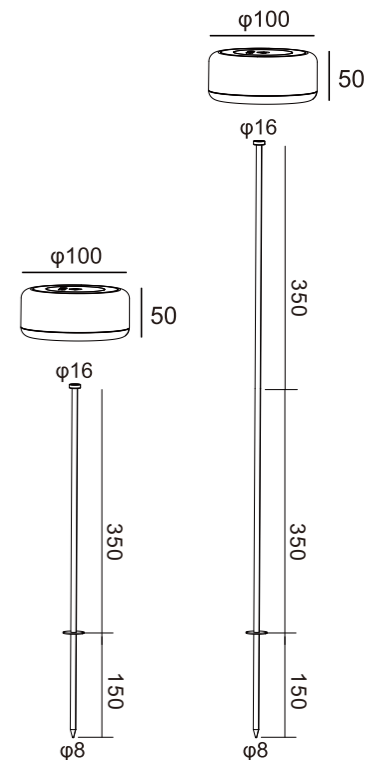

You can use the plug-in accessory when you are camping or partying outdoors.

The product can be plug into the lawn, next to trees, soft ground, or next to steps.

We offer two heights of 850mm and 500mm accessories for you to choose



HR95041

Orders your style

Technical data

- ⊗ 5V, 1A input voltage
- ⊗ 2.0W 200lm, led chips
- ⊗ 2x2200mAh Li-ion battery
- ⊗ Plastic material.
- ⊗ Charging time: 7-8h | Working time: >8h

 The battery capacity can be increased

Table Lamp



Magnetic Charging | USB 1.5M 5V 1A

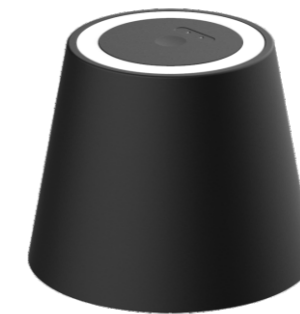
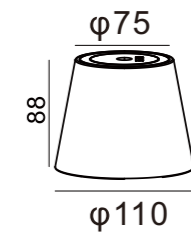

[How to DIY CCT?]

- ⊗ 1: Touch switch to turn on the light with 3000K RA>80 color.
- ⊗ 2: Touch switch with the 4000K RA>80
- ⊗ 3: Touch switch to turn off the lamp

[How to DIM?]



Table Lamp

DIY01-Table Lamp
Art Nr.HR95042-365

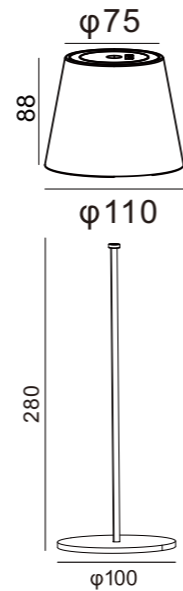

It is a multifunctional and portable LED magnetic charging table lamp that can be used outdoors and indoors.

Designed with DIY accessories to suitable for a variety of applications: tables, floors etc.... open Spaces.

Floor Lamp

DIY02-Floor Lamp
Art Nr.HR95043-1130

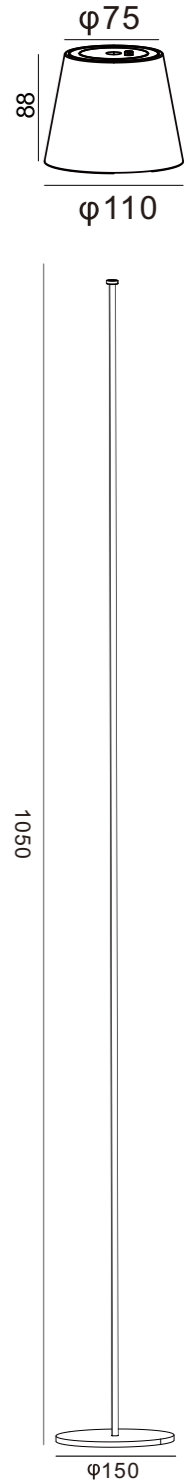

1050mm floor lamp accessories can let you use in the study, office area, leisure area , cafes, bars, and other areas.

Bottles Lamp

DIY03-Bottles Lamp
Art Nr. **HR95045**



When you have a collection of beautiful empty bottles
You can choose this accessory. It's alum. material with a
>4 kg of magnetic.

You can use it for indoor desks, office areas, cafes, bars, etc.

outdoor camping during the festival party, dining tables and other areas

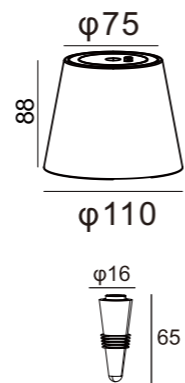

Plug Lamp

DIY04-Plug Lamp
Art Nr. **HR95044-425 | HR95045-775**



You can use the plug-in accessory when you are
camping or partying outdoors.

The product plug into the lawn, next to trees, soft
ground, or next to steps.

We offer two heights of 850mm and 500mm accessories
for you to choose.

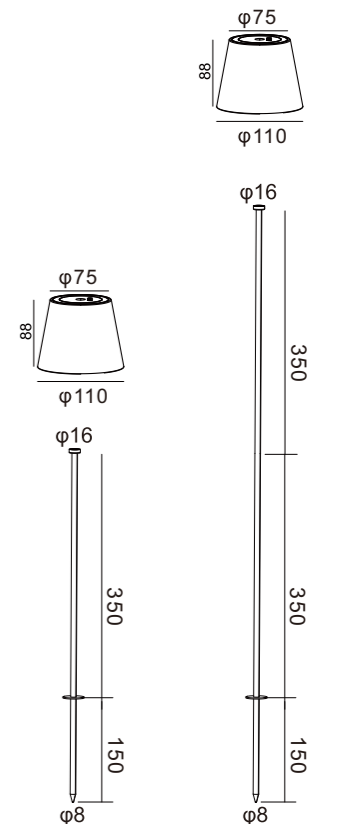



HR95051

Orders your style

Technical data

- ⊗ 5V, 1A input voltage
- ⊗ 2.0W 200lm, led chips
- ⊗ 1x4000mAh Li-ion battery
- ⊗ Plastic material.
- ⊗ Charging time: 6-7h | Working time: >7h

 The battery capacity can be increased

Table Lamp



Magnetic Charging | USB 1.5M 5V 1A

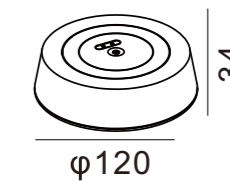

[How to DIY CCT?]

- ⊗ 1: Touch switch to turn on the light with 3000K RA>80 color.
- ⊗ 2: Touch switch with the 4000K RA>80
- ⊗ 3: Touch switch to turn off the lamp

[How to DIM?]



Table Lamp

DIY01-Table Lamp
Art Nr.HR90052-320

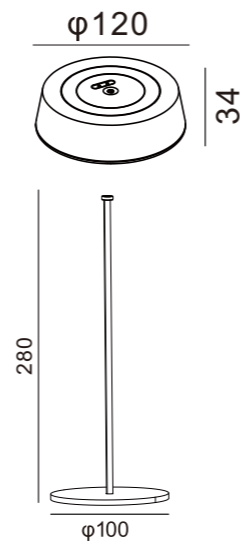

It is a multifunctional and portable LED magnetic charging table lamp that can be used outdoors and indoors.

Designed with DIY accessories to suitable for a variety of applications: tables, floors etc.... open Spaces.

Floor Lamp

DIY02-Floor Lamp
Art Nr.HR90053-1090

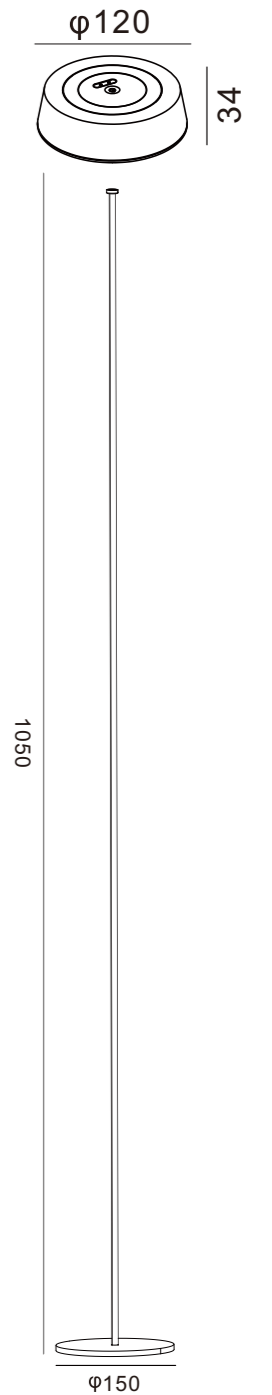

1050mm floor lamp accessories can let you use in the study, office area, leisure area ,cafes, bars, and other areas.

Bottles Lamp

DIY03-Bottles Lamp
Art Nr. **HR95055**



When you have a collection of beautiful empty bottles
You can choose this accessory. It's alum. material with a
>4 kg of magnetic.

You can use it for: indoor desks, office areas, cafes, bars, etc.

outdoor camping during the festival party, dining tables and other areas

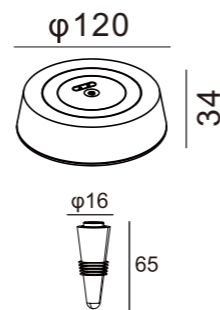

Plug Lamp

DIY04-Plug Lamp
Art Nr. **HR95054-385 | HR95054-735**



You can use the plug-in accessory when you are
camping or partying outdoors.

The product plug into the lawn, next to trees, soft
ground, or next to steps.

We offer two heights of 850mm and 500mm accessories
for you to choose.

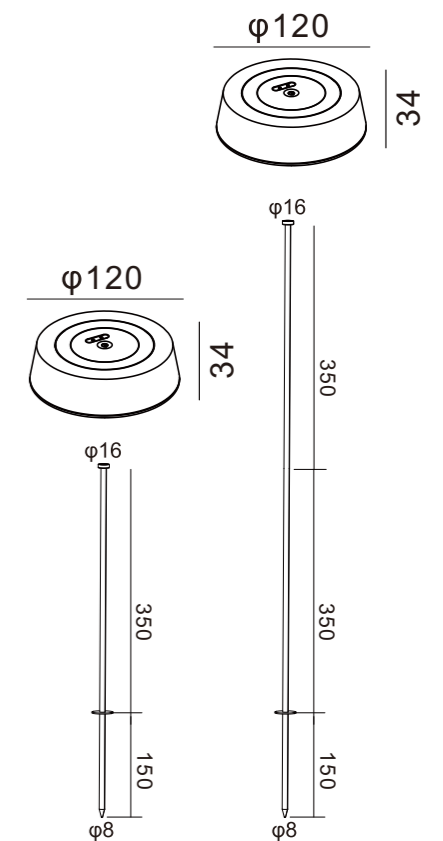



Hr95031 | HR95032

Orders your style

Technical data

- ⊗ 5V, 1A input voltage
- ⊗ 2.0W 200lm, led chips
- ⊗ 1x4000mAh Li-ion battery
- ⊗ Plastic material.
- ⊗ Charging time: 6-7h | Working time: >7h

 The battery capacity can be increased

Table Lamp



Magnetic Charging | USB 1.5M 5V 1A

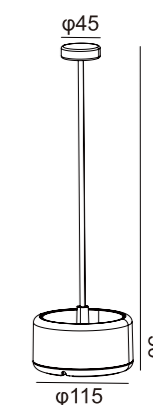

[How to DIY CCT?]

- ⊗ Touch switch, ON or OFF
- ⊗ Touch switch to choose the CCT for 4000K RA>95

[How to DIM?]





Gold



White



Silver



Gold



White



Silver



Black



Red



Green



Blue



Black

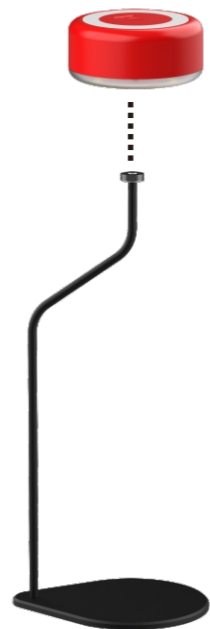

Red



Green

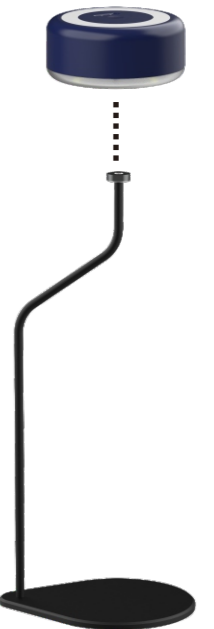

Blue

The lamps are not suitable for outdoor use



Gold



White



Silver



Gold



White



Silver



Black



Red



Green



Blue



Black



Red



Green



Blue

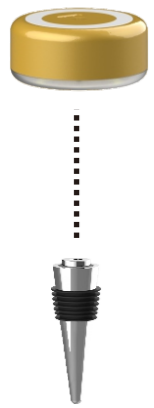

Gold

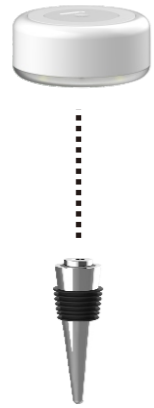

White

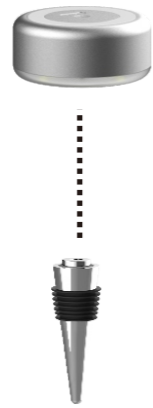

Silver



Gold



White



Silver



Black



Red



Green



Blue



Black



Red



Green



Blue



Gold



White



Silver



Gold



White

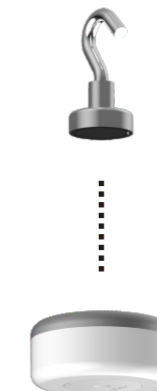

Silver



Black



Red



Green



Blue



Black



Red



Green



Blue

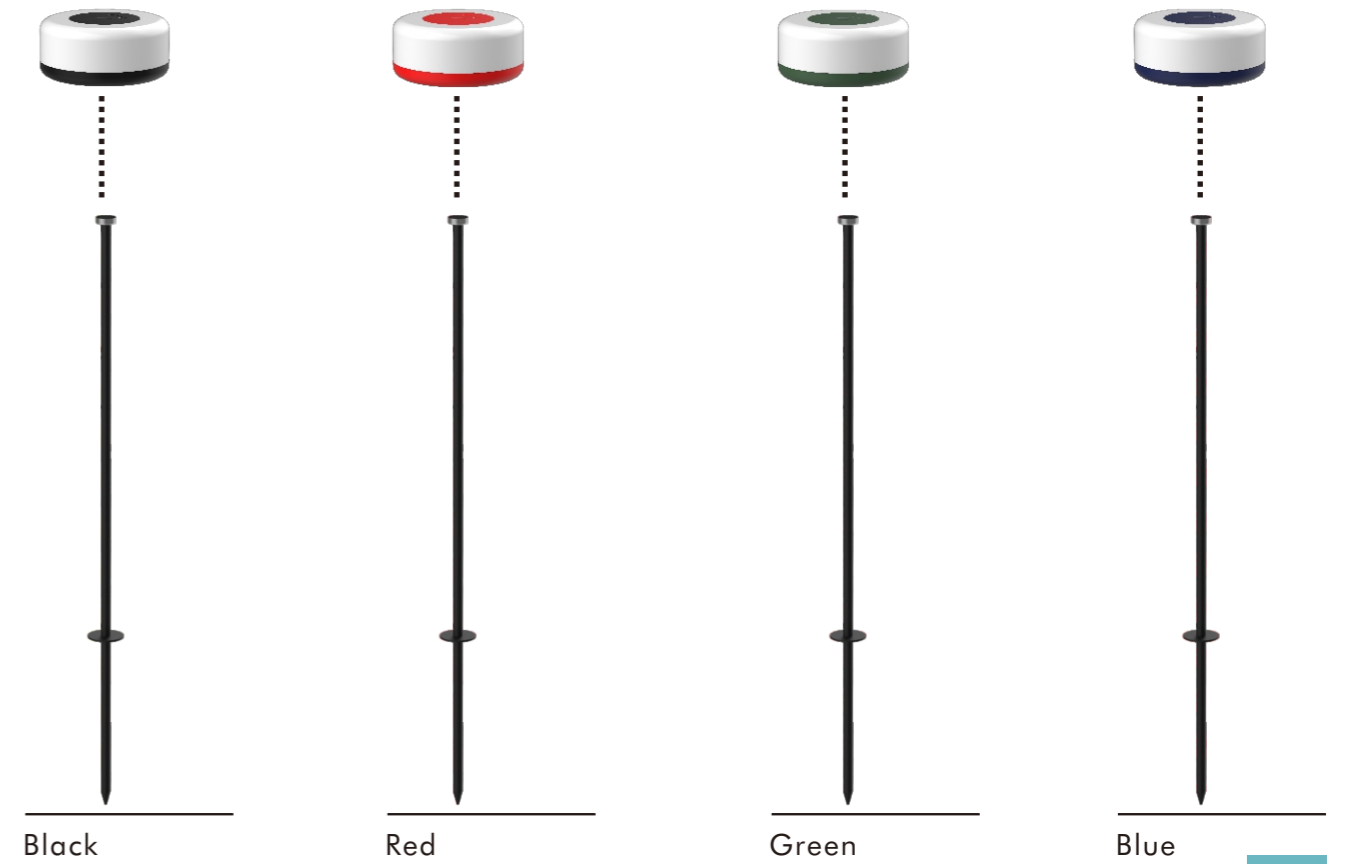
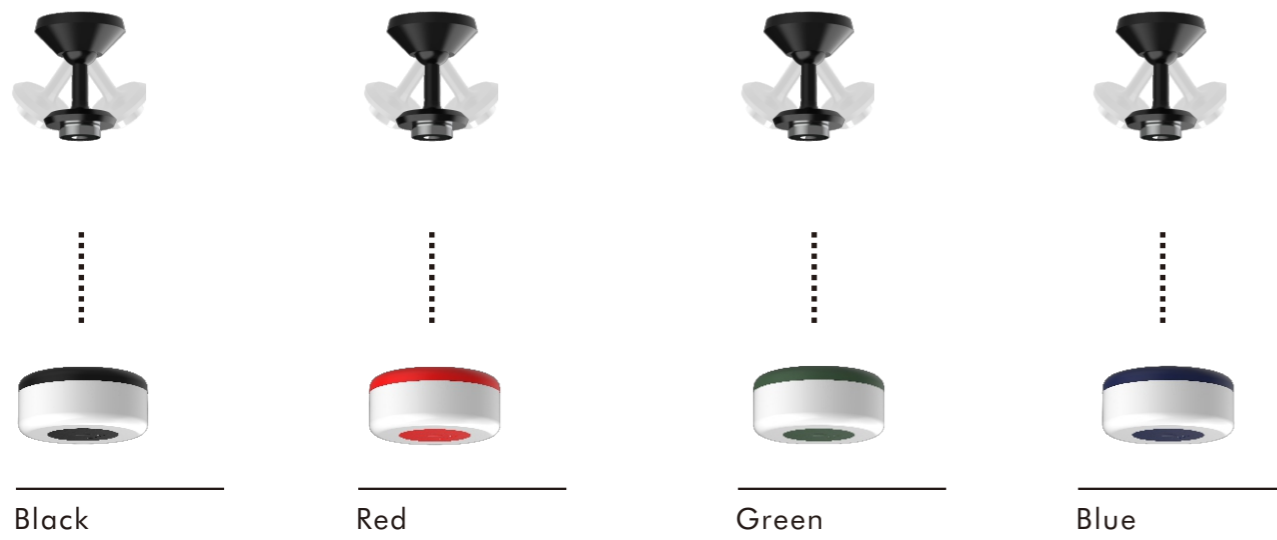
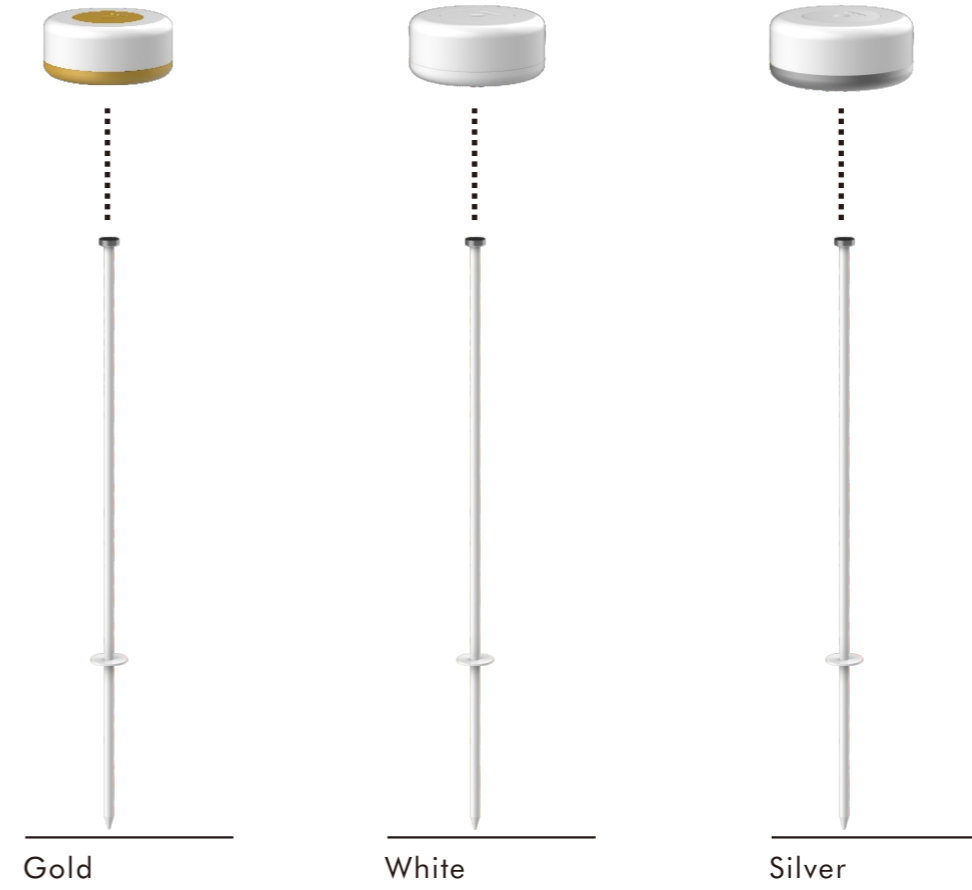
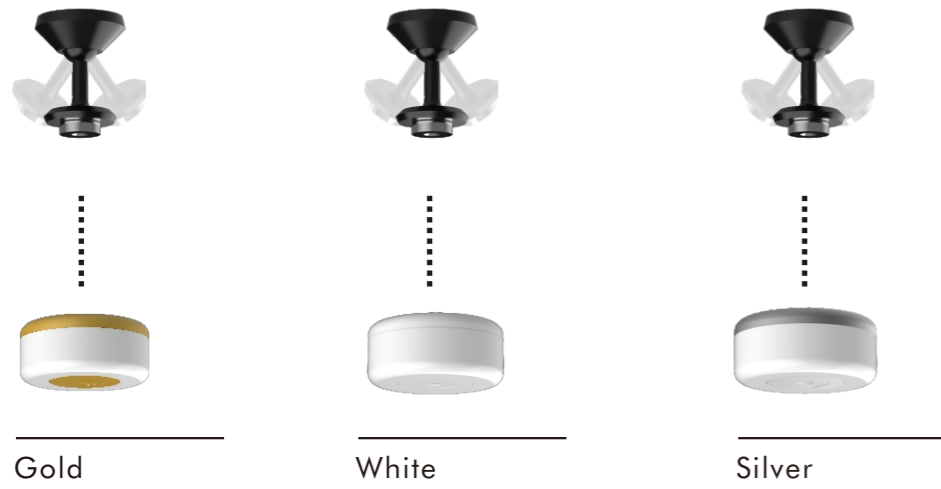



Gold



White



Silver



Gold



White



Silver



Black



Red



Green



Blue



Black



Red



Green



Blue



Gold



White



Silver



Gold



White



Silver

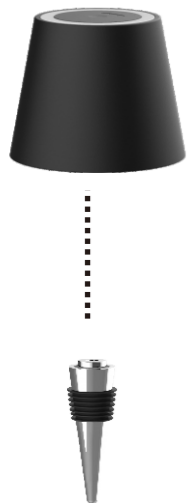

Black



Red



Green

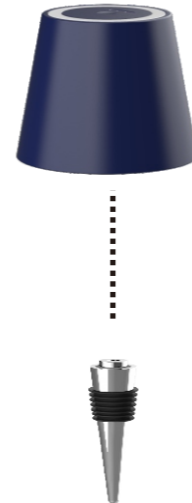

Blue



Black



Red



Green



Blue



Gold

White

Silver



Gold

White

Silver



Black

Red

Green

Blue

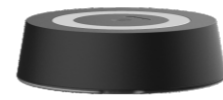

Black

Red

Green

Blue



Gold



White



Silver



Gold



White

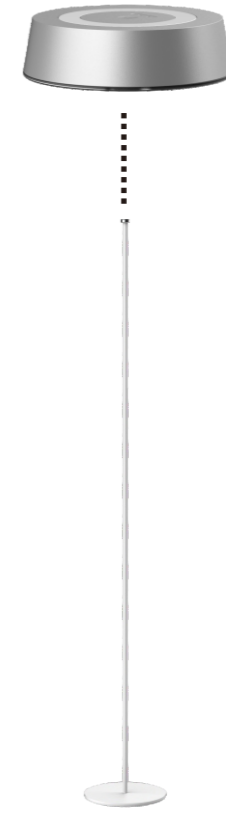

Silver



Black



Red



Green



Blue

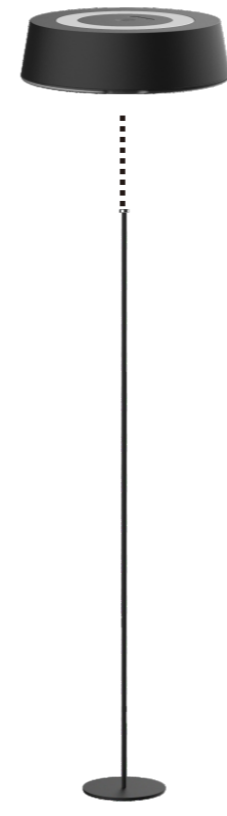

Black



Red



Green

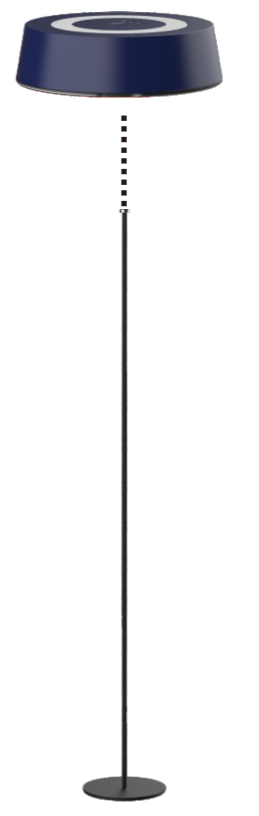

Blue



Technology Data-Products

- ⊗ LED 2W, 180lm
- ⊗ 2200mAh 3.7V Li-ion battery
- ⊗ Body in ABS+PC.
- ⊗ Diffuser in Frosted PC.
- ⊗ Charging time: 6-7h | Working time: >3h

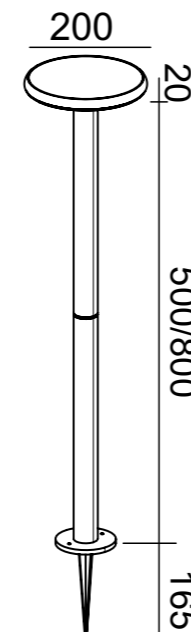
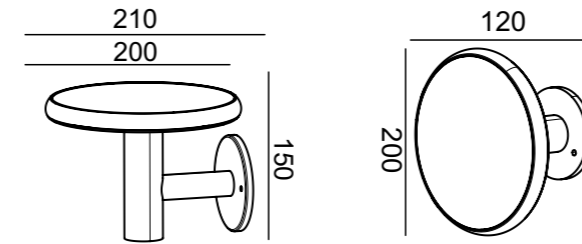

Technology Data-Operating mode

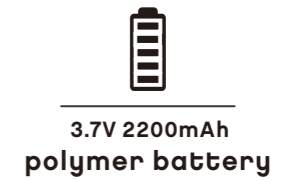
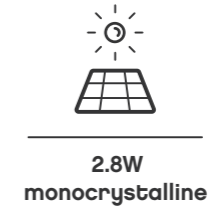

Push button switch control



☀️ Hold the switch for 3S to control the microwave sensor function -- on or off

Adjustable Color



☀️ Push the Switch to fix the color
3000K - 6000K - 4000K - off
Microwave induction function is on:
3000K light30%-light100%(motion sensor)
6000K light30%-light100%(motion sensor)
4000K light30%-light100%(motion sensor)



HR90032



HR90031



HR90033-500
HR90033-800

